

EE-172 Final Project

- 1) 2 by 2 Dipole Antenna Array with a Stripline Power Divider
- 2) 2 by 2 Monopole Antenna Array with three-stage Wilkinson Power Divider

EE-172

San Jose State University

Professor Ray Kwok

By:

Mike Ridgeway

December 15, 2012

1. Table of Contents

1.	Table of Contents	2
2.	Table of Figures	3
3.	Abstract.....	5
4.	Design: The 2 by 2 Dipole Antenna Array using a Stripline Power Divider	6
	Estimation of the Radiation Pattern.....	7
	Simulations using 4nec2	11
	Stripline Power Divider concept and dimensions	13
5.	Design: The Wilkinson Power divider 2 by 2 Monopole Antenna Array	16
6.	Implementation/Parts and Tools	19
	Parts for the Stripline Power Divider and RG58 based antennas.....	19
	Parts for the Wilkinson Power Divider.....	19
	General Tools and parts	19
	The 2 by 2 Dipole Antenna Array with Stripline Power divider	20
	The construction of the 2 by 2 array with Wilkinson Power Divider.....	24
7.	Experimental Results.....	25
	Testing Procedure.....	25
	2 by 2 Dipole array with Stripline	25
	Radiation patterns of the 2 by 2 Dipole Antenna	28
	The XY-plane radiation plots.....	28
	The XZ-plane radiation plots	29
	The YZ-plane radiation plots	30
	Measured Radiation Patterns of the 2 by 2 Monopole Array with Wilkinson power divider ..	31
8.	Conclusion	34
9.	Bibliography	37

2. Table of Figures

Figure 1: General wavelengths for 2.4GHz.....	6
Figure 2: The calculations of the half-wave length of the whole Dipole antenna, and the quarter-wave lengths using factorA.	6
Figure 3: The factorA along with the ratio (Electronics+Radio Today, 2012).	6
Figure 4: The FactorA chart (Electronics+Radio Today, 2012).....	7
Figure 5: The Radiation pattern for a single Dipole antenna.	8
Figure 6: The pattern array factor for $\lambda/2$ separation with the Radiation pattern of the 2 by 1 stage with $\lambda/2$ separation.	9
Figure 7: The pattern factor for the 1 by 2 with λ separation with the estimated radiation pattern for the 2 by 2 Dipole antenna array.....	10
Figure 8: The Visual of the 2 by 2 Dipole Antenna array for the estimation of the radiation pattern.....	10
Figure 9: Initial simulation settings for 2 by 2 with $\lambda/2$ and λ separation with 3D and 2D plots of total gain.	11
Figure 10: The simulation settings for the 2 by 2 Dipole antenna array that was built.	12
Figure 11: The simulated 2 by 2 gain pattern in Z- XY plane, the X-Y plane, and 3D gain plot.	12
Figure 12: The copper center conductor dimensions for a quarter-wave section of the Stripline.	13
Figure 13: The setup of the 2 by 2 array using 50 Ω loads as the antennas to simulate the stripline set up.	14
Figure 14: The Stripline power divider using half-wave length center conductor, the BNC panel mounts are connected in such a way to get the benefits of a quarter-wave. The transmission lines have been replaced with resistors to show concept.....	15
Figure 15: The TXline editor with the microstrip's dimensions.	16
Figure 16: The 2 by 2 Monopole with Wilkinson Power Divider.	17
Figure 17: Progression for a single-stage of the Wilkinson Power divider.....	17
Figure 18: The S11 plot of the 2 by 2 Monopole array using a Wilkinson Power divider shows the match at 2.4GHz at 50 Ω	18
Figure 19: The simulated radiation pattern for the 2 by 2 Monopole array.	18
Figure 20: The general design of the 2 by 2 Dipole array.....	21
Figure 21: The Dipole Antennas after construction and before electrical tape was used to make the separation between the two quarter-wave wires smaller. Construction of the stripline power divider with a side view as well as a view of the center conductor. The completed 2 by 2 Dipole Antenna Array.....	22
Figure 22: The 2 by 2 Monopole array using three stages of the Wilkinson Power divider.	24
Figure 23: Calibrating the Spectrum Analyzer. Image on the right, the reference antenna used with -20.6dB at 734MHz.....	25
Figure 24: Antennas with -13.6dB at 2.28GHz, -19.9dB at 2.19GHz, -17.1dB at 2.18GHz, and -19.2dB at 2.18GHz	26
Figure 25: The test setup with the stool and string. The string was used to keep a consistent distance from the 2 by 2 Dipole array.	27
Figure 26: The test setup with the tripod and string.	27
Figure 27: The XY-plane radiation patterns along with the 4nec2 simulated radiation pattern.	28

Figure 28: Data was not gathered from 230 degrees to 310 degrees due to the space under the stool. So the average plot does not take those missed places into consideration. The simulated 4nec2 radiation pattern is also shown.	29
Figure 29: The Radiation patterns for the YZ-plane.....	30
Figure 30: The setup and S11 measurement.....	31
Figure 31: The Measured XY plane radiation compared with simulated pattern.....	32
Figure 32: The measured radiation pattern compared with the XZ-plane	32
Figure 33: The radiation patterns of the YZ plane and the simulated pattern.	33
Figure 34: The N-type female connector on the 2 by 2 Monopole array that was not grounded..	36

3. Abstract

Two designs were used to implement the 2 by 2 antenna array. One design followed the general outline of the previous EE-172 project by Mr. Tao and the second implementation used three stages of Wilkinson power dividers using microstrips with Monopole antennas.

The 2 by 2 Dipole Antenna Array was built using a four-way stripline power divider with four Dipole antennas designed for 2.4GHz. The Dipole antennas were assembled using RG-58A/U coaxial cable, RG-58 to BNC male connectors, and 20 AWG copper wire. The stripline power divider was built using a copper center conductor, BNC female panel mounts, and an aluminum shell. The design started with researching the basics of antennas and antenna arrays. The dimensions of the design were first sketched by hand for a rough estimate of the Radiation pattern and then simulated using 4nec2. The dimensions of the copper center conductor for the stripline were determined using Microwave Office's TXline editor, since the center conductor was different from the previous EE-172 project.

The 2 by 2 Monopole antenna array used aluminum foil for microstrips, three 100Ω resistors, and 0.23 inch thick insulator. The dimensions of the microstrips were determined using Microwave Office's TXline editor.

The 2 by 2 Dipole Array's measured radiation patterns showed similarities to the simulated radiation patterns while the 2 by 2 Monopole Array's results proved not be valid due to errors in implementing the design.

4. Design: The 2 by 2 Dipole Antenna Array using a Stripline Power Divider

The 2 by 2 Dipole Antenna array was designed for 2.4GHz. Half-wave Dipole Antennas were designed, and consisted of two quarter-wave wires. The lengths of the copper wires were calculated using the desired frequency, 2.4GHz, and factorA, which relate the diameter of the copper wire to the wavelength, λ . The ratio of $\frac{\lambda}{diameter}$ was used to find the appropriate FactorA from the chart provided on Electronics+Radio Today (2012). The calculations are provided below. The length of each $\frac{\lambda}{4}$ segment was 3cm.

$$wavelength = \lambda = \frac{c}{freq} = \frac{(3 \times 10^8 \frac{m}{s})}{2.4GHz} = 0.125m = 12.5cm$$

$$half - wave length = \frac{\lambda}{2} = \frac{c}{freq} \times \frac{1}{2} = \frac{(3 \times 10^8 \frac{m}{s})}{2.4GHz} \times \frac{1}{2} = 0.0625m = 6.25cm$$

Figure 1: General wavelengths for 2.4GHz.

$$Length\ of\ total\ wire = \frac{\lambda}{2} \times factorA = \frac{c}{freq} \times \frac{1}{2} \times factorA = \frac{(3 \times 10^8 \frac{m}{s})}{2.4GHz} \times \frac{1}{2} \times 0.96$$

$$Length\ of\ total\ wire = 0.06m = 6cm$$

$$Each\ wire\ segment = \frac{Length\ of\ total\ wire}{2} = \frac{0.06m}{2} = 0.03m = 3cm$$

Figure 2: The calculations of the half-wave length of the whole Dipole antenna, and the quarter-wave lengths using factorA.

$$factorA \approx 0.96 \Rightarrow \frac{\lambda}{diameter\ _\ of\ _\ wire} = \frac{(3 \times 10^8 \frac{m}{s})}{2.4GHz \times 0.812mm} = 153.94$$

Figure 3: The factorA along with the ratio (Electronics+Radio Today, 2012).

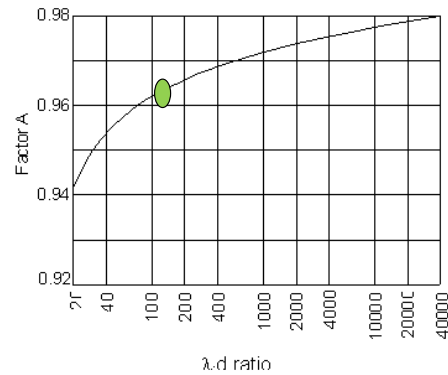

Figure 4: The Factor A chart (Electronics+Radio Today, 2012).

Estimation of the Radiation Pattern

After the lengths of the Dipole antennas were calculated, the estimation of the Radiation pattern of the 2 by 2 array was determined using the element pattern and array pattern factor. The initial design was for $\frac{\lambda}{2}$ separation between the Dipoles on the same level and λ separation between the two-sets of Dipoles as illustrated below. The radiation pattern was esimated with the 2 by 1 Dipole with $d = \frac{\lambda}{2}$ separation using the Dipole element pattern, shown in the figures below. Then the 1 by 2 radiation pattern which led to to the total radiation pattern was done using the result of the 2 by 1 radiation pattern with the new pattern factor for $d = \lambda$ which resulted in the 2 by 2 radiation pattern estimate. But upon building the Dipole Antennas the separation became 42cm, or roughly 3.4λ . This will be discussed in the implementation section of the report.

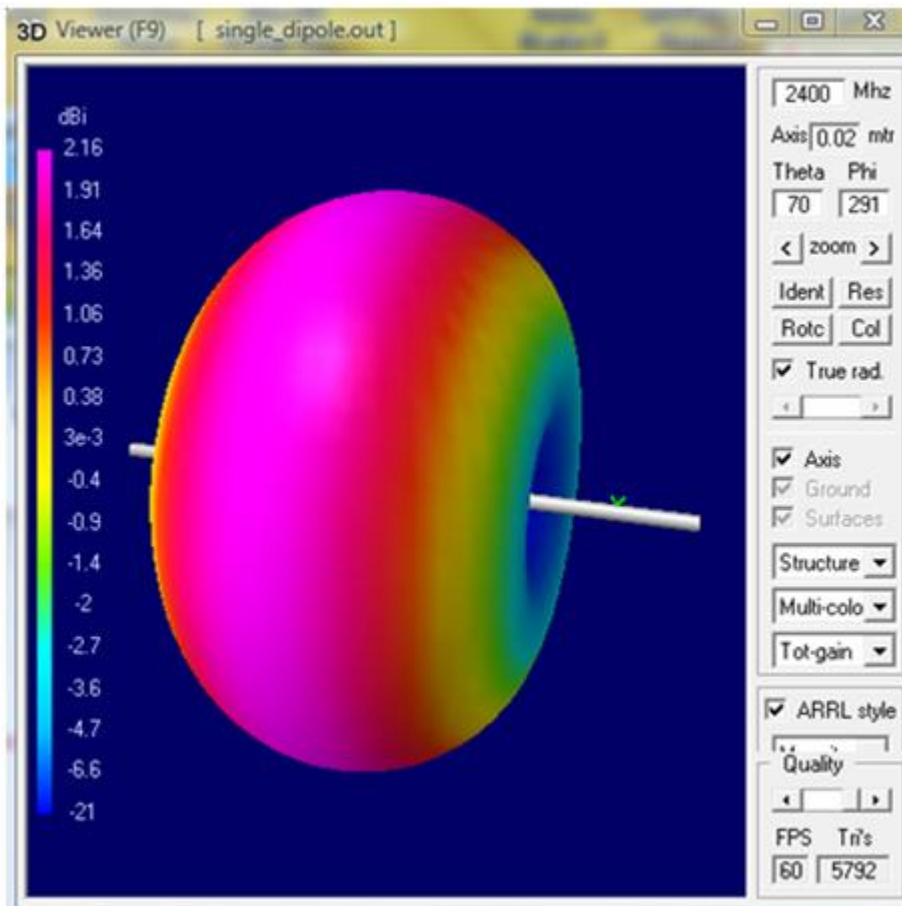

Figure 5: The Radiation pattern for a single Dipole antenna.

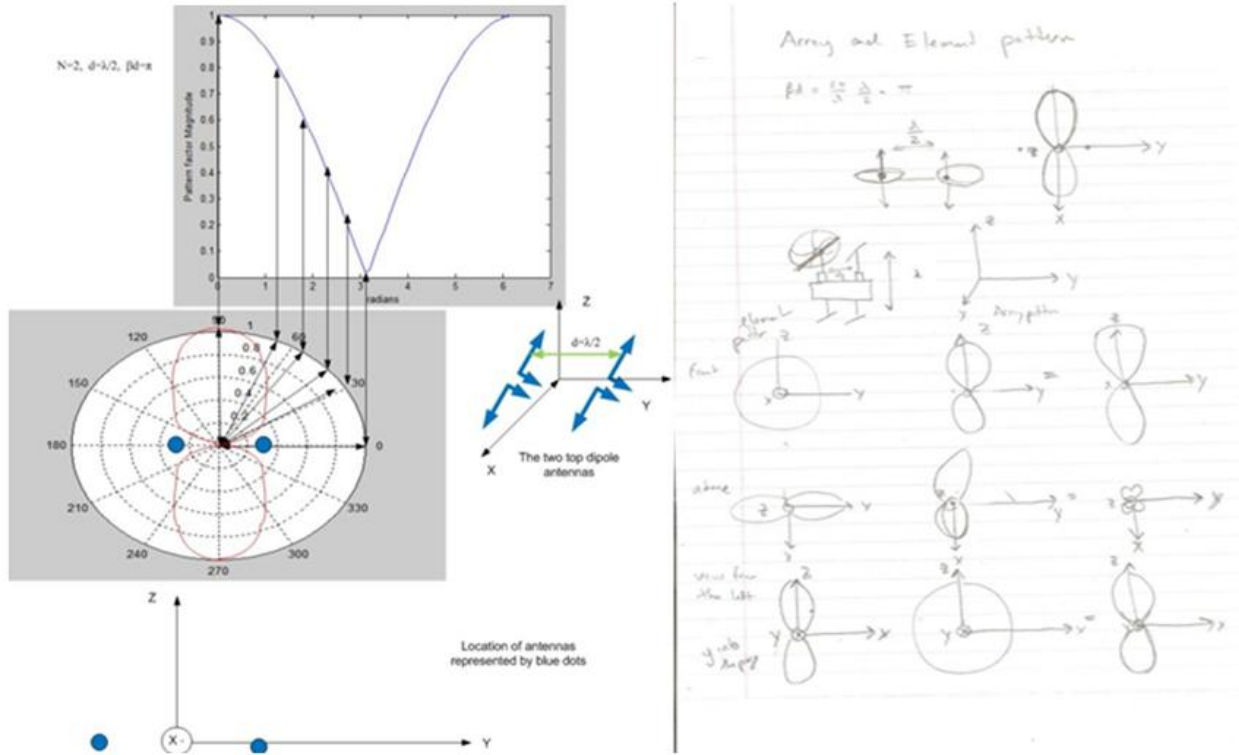

Figure 6: The pattern array factor for $\lambda/2$ separation with the Radiation pattern of the 2 by 1 stage with $\lambda/2$ separation.

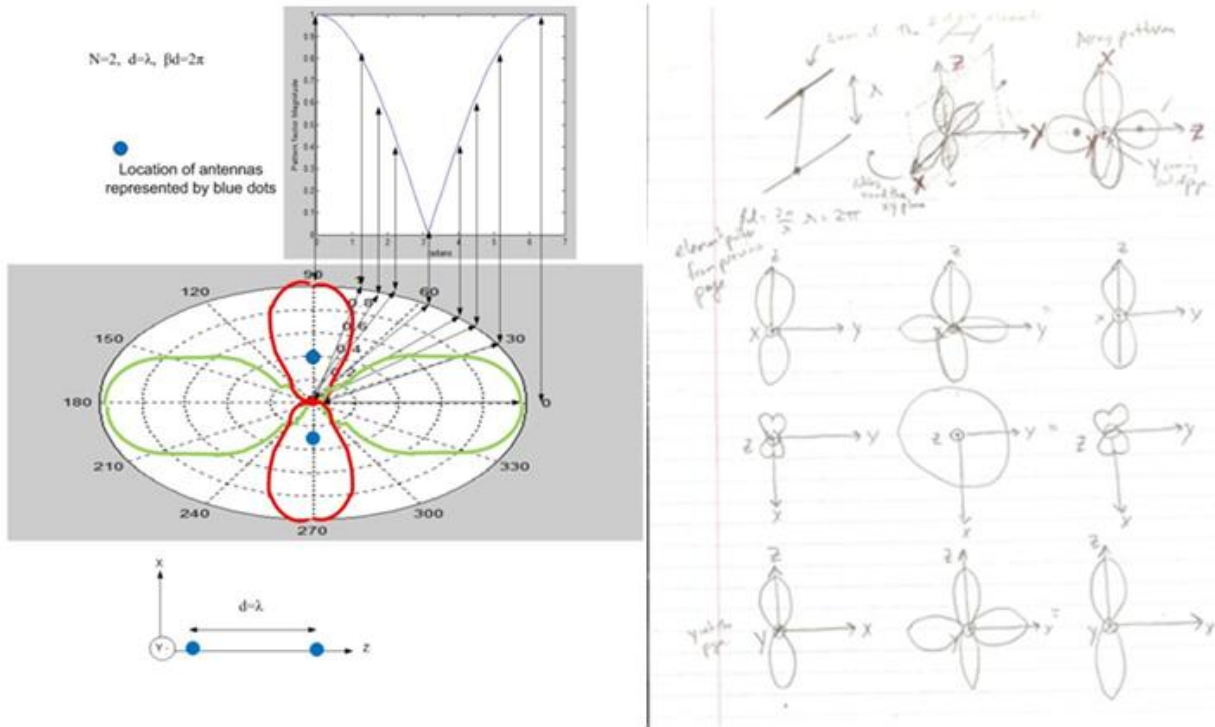

Figure 7: The pattern factor for the 1 by 2 with λ separation with the estimated radiation pattern for the 2 by 2 Dipole antenna array.

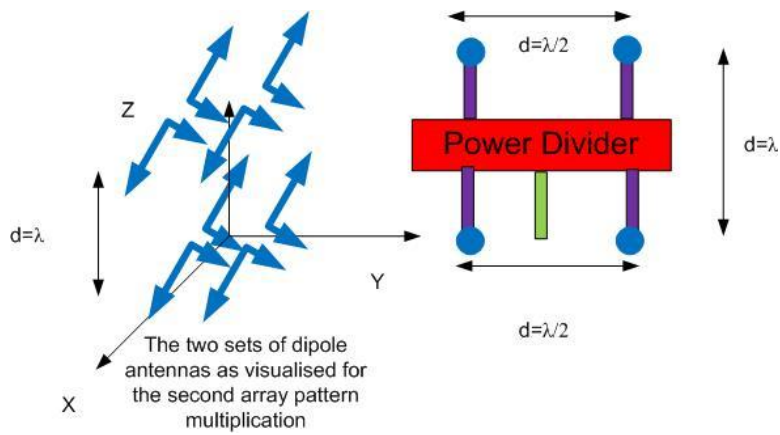

Figure 8: The Visual of the 2 by 2 Dipole Antenna array for the estimation of the radiation pattern.

Simulations using 4nec2

After the hand estimations were done, simulations for the Antenna Radiation patterns were done using 4nec2 (Voors, 2005). First a Dipole was simulated, and then a 2 by 2 Dipole antenna array. The simulations were first set up using the NEC geometry editor, but eventually after some tutorials and practice the NEC editor was used which allows the user to enter various parameters like a wire's length and diameter, which are shown in the following figures. The estimated hand drawn version matches the general outline of the simulated array of the same separations.

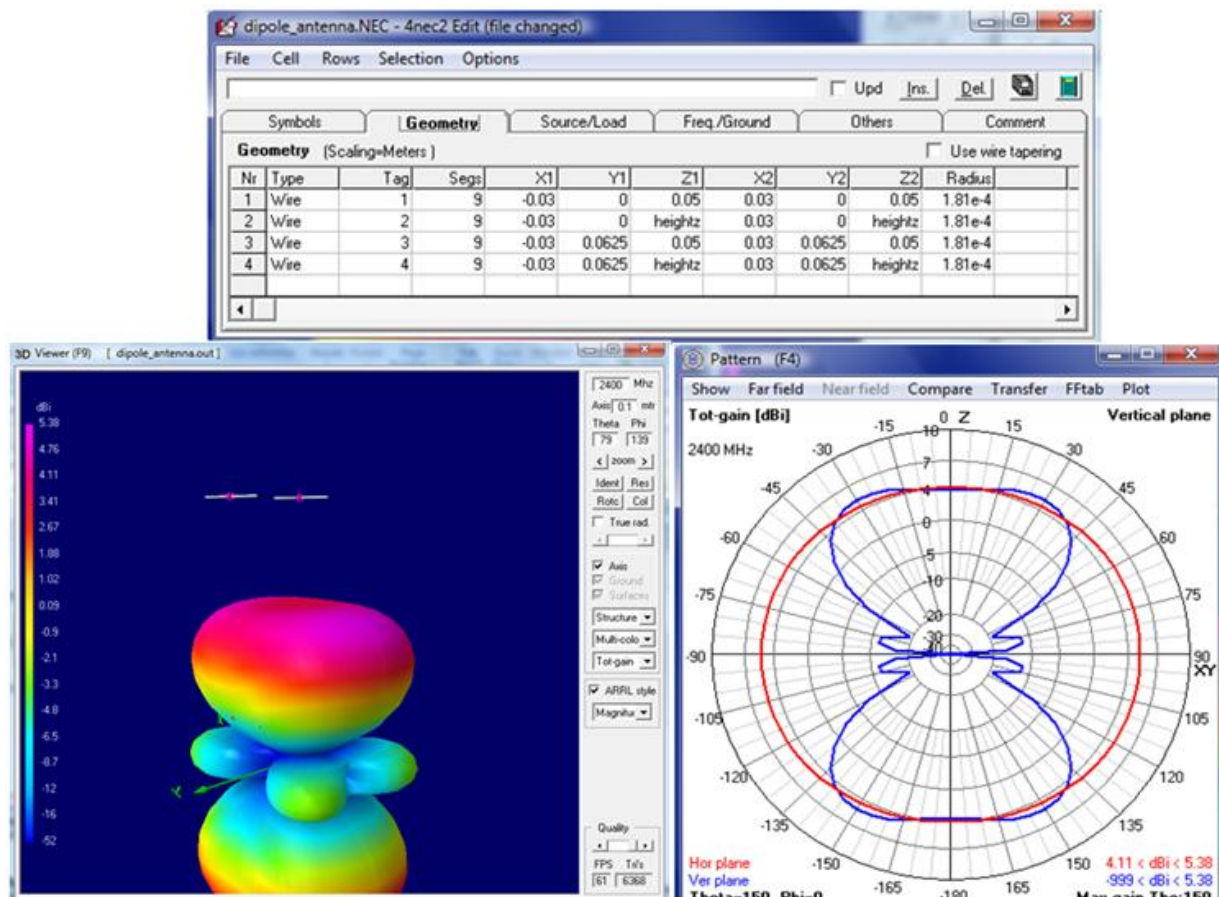

Figure 9: Initial simulation settings for 2 by 2 with $\lambda/2$ and λ separation with 3D and 2D plots of total gain.

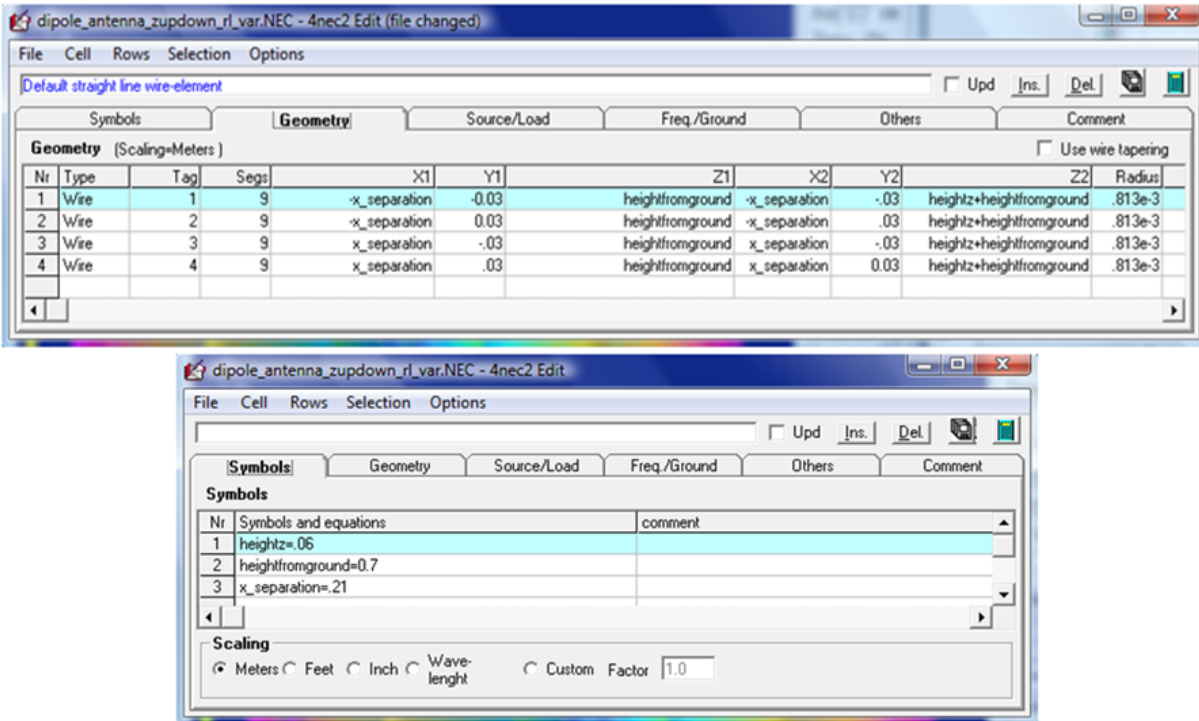

Figure 10: The simulation settings for the 2 by 2 Dipole antenna array that was built.

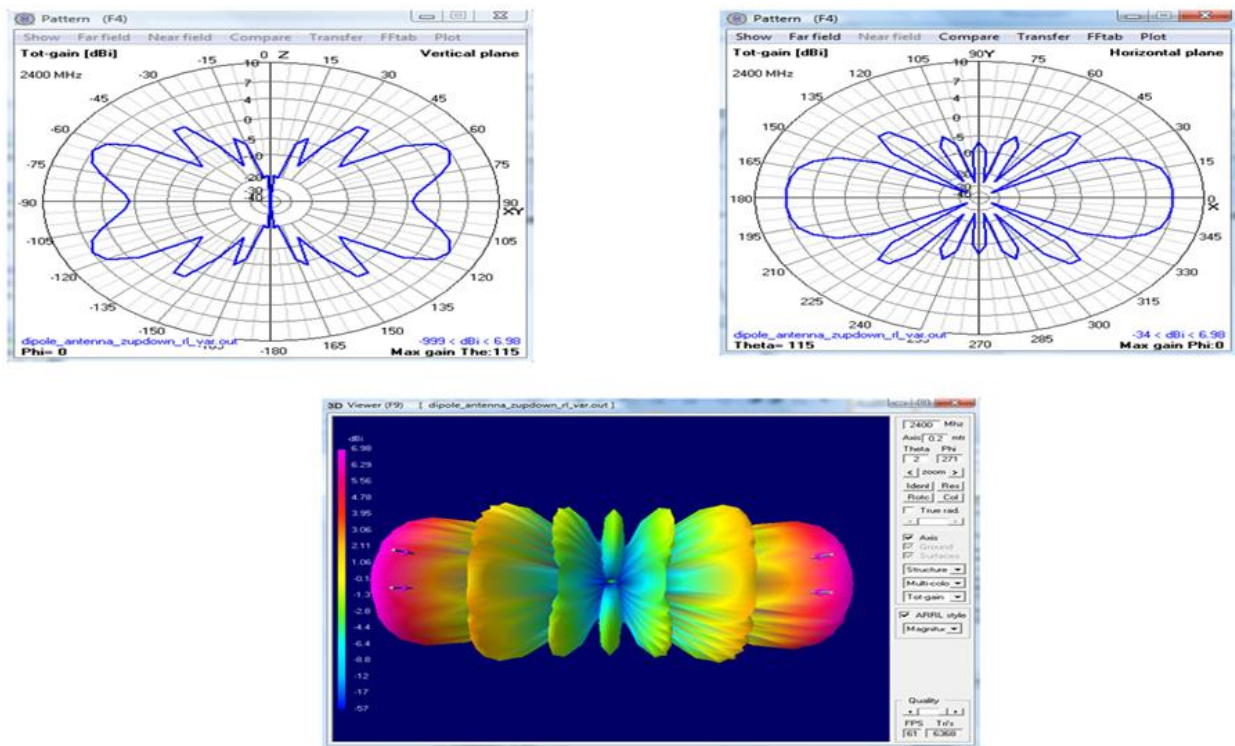

Figure 11: The simulated 2 by 2 gain pattern in Z- XY plane, the X-Y plane, and 3D gain plot.

Stripline Power Divider concept and dimensions

Now when determining the inner conductor dimensions of the stripline the previous EE172 report used a copper outside and a brass sheet stock center conductor (Tao, 2011). The website with the information on designing the stripline power divider was <http://www.packratvhf.com/article4.htm> (Whitsel, n.d.). There were various options for striplines described on the website and they had an option for 2.304GHz. The dimensions of the center conductor were adjusted since the tutorial used a brass sheet stock and copper was going to be used in this stripline. To determine the dimensions of the copper center conductor, Microwave Office's TXline tool was used, as shown in the figures below. The piece of copper being used was of 0.025mm thickness and this was entered along with the design constraints of 2.4GHz and quarter-wave properties along with a 50Ω impedance, producing a total half-wave length of 2.5in and a width of 0.58in.

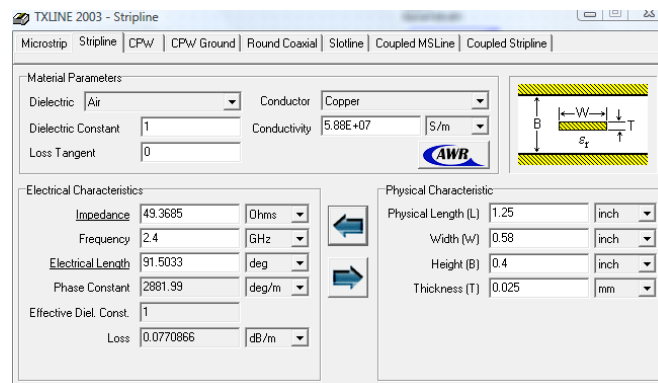

Figure 12: The copper center conductor dimensions for a quarter-wave section of the Stripline.

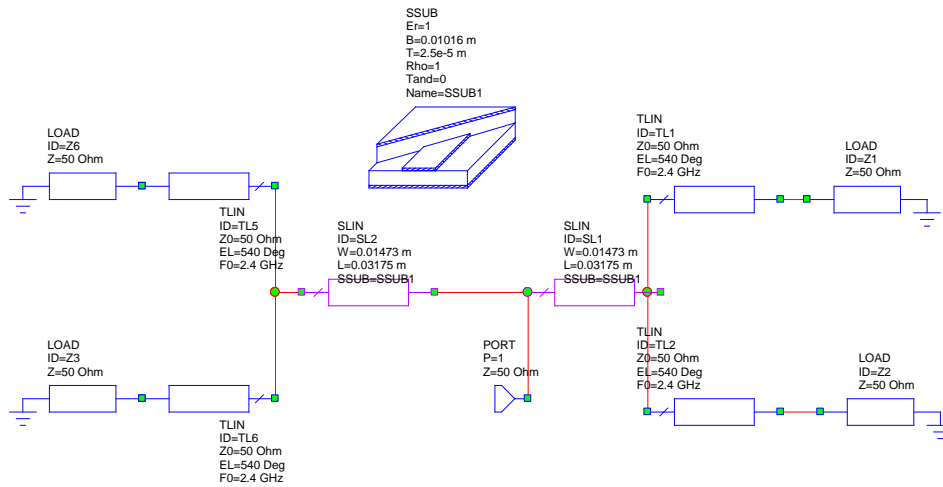

Figure 13: The setup of the 2 by 2 array using 50Ω loads as the antennas to simulate the stripline set up.

The stripline provides 50Ω to port 1, by the steps described in the following sentences and figures. In the figures below the transmission lines are replaced with 50 Ω resistors since the characteristic impedance of the transmission lines, 50 Ω for RG-58A, is connected to a 50Ω load, resulting in 50Ω (Whitsel, n.d.). The 50Ω transmission lines are added in parallel on each end to get 25Ω. The center feeder needs to be matched to 50Ω, so the copper center conductor is designed to be half-wave in length, but connected to the BNC female panel mounts in quarter-wave length segments. The stripline is designed to have an impedance of 50Ω, and having quarter-wave properties, the $Z_{in} = \frac{Z_0^2}{Z_L} = \frac{50^2}{25} = 100\Omega$. Now with the two sides $100\Omega || 100\Omega = 50\Omega$, the center feeder is matched to 50Ω. The progression of the steps is shown in the figures below, with the transmission lines replaced with resistors to show the concept.

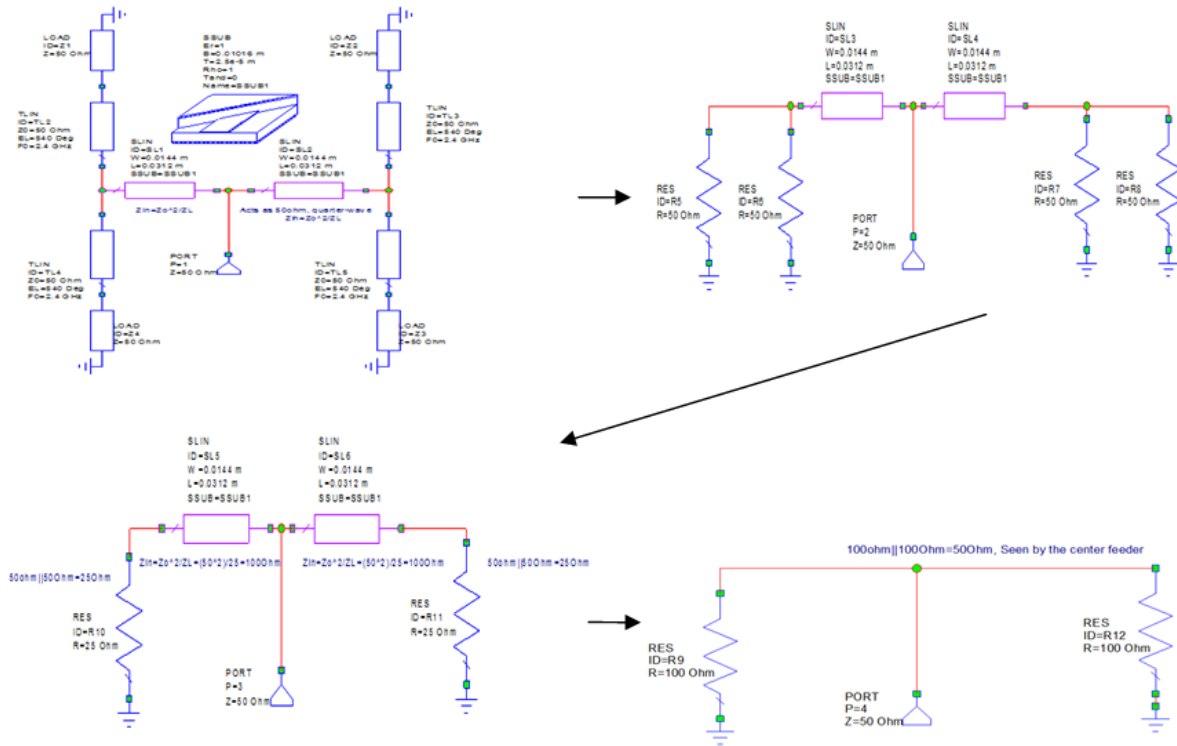

Figure 14: The Stripline power divider using half-wave length center conductor, the BNC panel mounts are connected in such a way to get the benefits of a quarter-wave. The transmission lines have been replaced with resistors to show concept.

5. Design: The Wilkinson Power divider 2 by 2 Monopole Antenna Array

The 2 by 2 Monopole array has similar properties to that of the Dipole array. The radiation pattern of the Monopole is similar to that of a Dipole, but the Monopole needs a large conductive plate to replace the other wire half (Stutzman, 1981, pp. 87-88). Since the design does not have a large conductive material below the antenna, the expected radiation pattern for the design is in question. To determine the dimensions of a 70.7Ω piece of quarter-wave aluminum foil, Microwave Office's TXline editor was used. The design constraints were the insulator thickness of 0.23 inches, the thickness of the aluminum foil was 0.016mm, and the 2.4GHz frequency, as shown in the figure below. The dielectric constant of the wood insulator was assumed to be $\epsilon_r = 1.5$, but the dielectric constant of wood varies with the type of wood. The dimensions of the aluminum foil were estimated to be 1.04inches by .55 inches, with a thickness of 0.016mm. The design required three stages of the Wilkinson power divider to accommodate the five connections required, four for the antennas, and one for the connection to the spectrum analyzer.

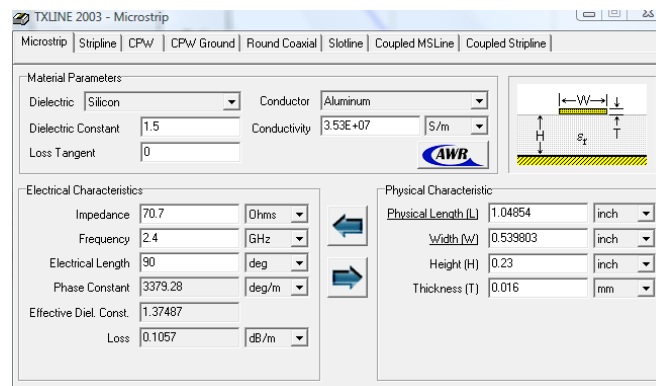

Figure 15: The TXline editor with the microstrip's dimensions.

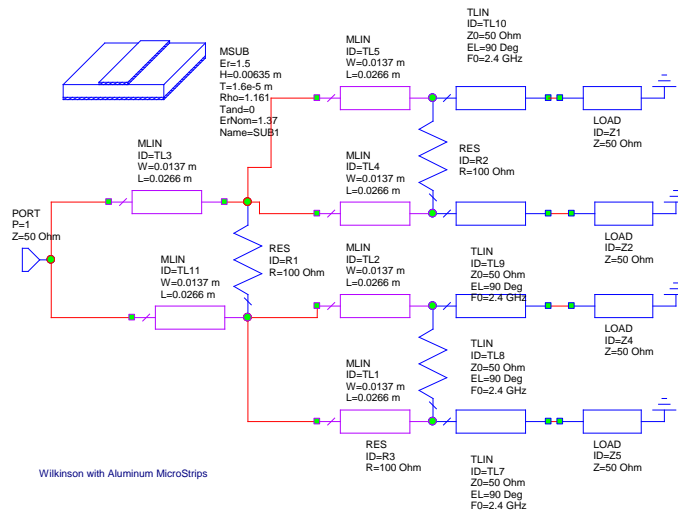

Figure 16: The 2 by 2 Monopole with Wilkinson Power Divider.

$$Z_{in-tl5} = \frac{Z_{characteristic_{line}}^2}{Z_{load}} = \frac{(\sqrt{2}Z_0)^2}{Z_0} = \frac{2Z_0^2}{Z_0} = 2Z_0 = 100\Omega$$

$$Z_{in-tl4} = \frac{Z_{characteristic_{line}}^2}{Z_{load}} = \frac{(\sqrt{2}Z_0)^2}{Z_0} = \frac{2Z_0^2}{Z_0} = 2Z_0 = 100\Omega$$

$$\text{where } Z_0 = 50\Omega, \sqrt{2}Z_0 = 70.7\Omega$$

$$Z_{in-tl4} || Z_{in-tl4} = 100\Omega || 100\Omega = 50\Omega$$

Figure 17: Progression for a single-stage of the Wilkinson Power divider.

The Wilkinson Power divider matches the input port to 50Ω , with four output ports. The microstrip transmission lines have quarter-wave properties and since the four loads connected should be the same ideally, 50Ω , after the quarter-wave microstrip increases the viewed impedance to 100Ω . The 100Ω impedance in parallel results in 50Ω at the end of each Wilkinson power divider stage. “The 100Ω resistors are assumed to not be dissipating power” (Poza, 2012, pp. 330-331). The Wilkinson power divider is assumed have equal loads so that the

100 Ω resistors can be ignored, since potential is the same at both sides of the resistor (Pozar, 2012, pp. 330-331). The S_{11} plot from Microwave Office of the schematic and the simulation of the 2 by 2 array's radiation pattern are shown below.

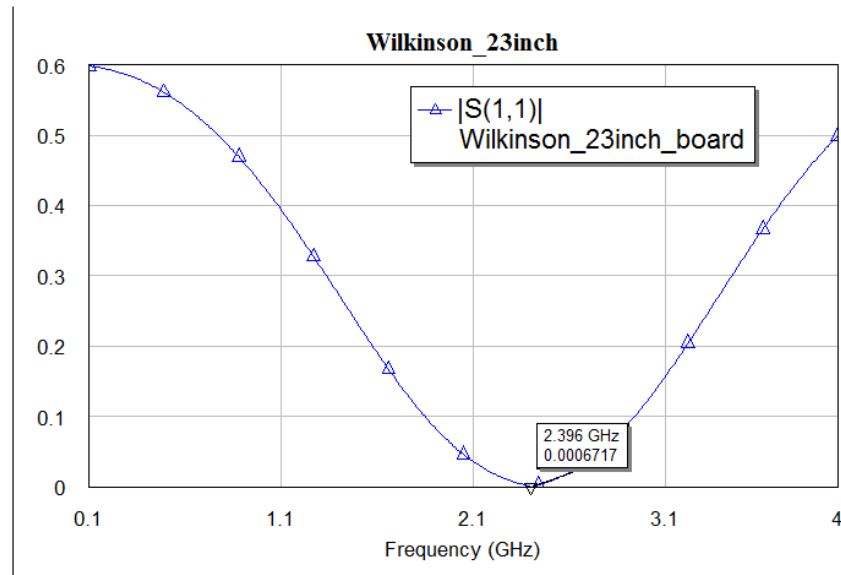

Figure 18: The S11 plot of the 2 by 2 Monopole array using a Wilkinson Power divider shows the match at 2.4GHz at 50 Ω .

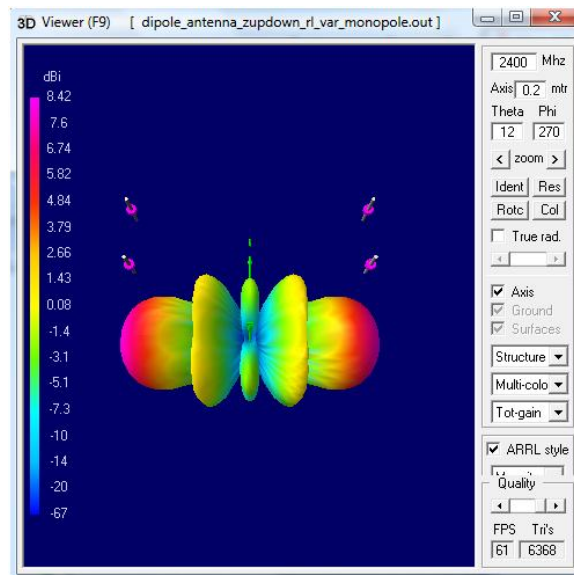

Figure 19: The simulated radiation pattern for the 2 by 2 Monopole array.

6. Implementation/Parts and Tools

Parts for the Stripline Power Divider and RG58 based antennas

- Five BNC female flat panel mounts (for the Power divider)
- RG-58A/U coaxial cable (for the Dipole antennas)
- RG58 crimpers and wire strippers
- Five RG-58 to BNC male connectors
- Two BNC Male to N-type female adapters
- One BNC female to N-type female adapter
- Aluminum sheet, 0.025 inches thick
- Copper sheet, 0.025mm thick
- Copper wire, 20 AWG (for Dipole Antennas)

Parts for the Wilkinson Power Divider

- Wood insulator, 0.23 inch thick
- Three 100 Ω resistors
- Aluminum Foil, 0.016mm thick (Microstrips)
- Copper wire, 20 AWG (for Monopole Antennas)
- One N-type female flat mount connector

General Tools and parts

- Staples
- Glue

- Electrical tape
- Soldering Gun and Iron
- Clamps
- Drill
- Calipers

The 2 by 2 Dipole Antenna Array with Stripline Power divider

The half-wave Dipole antennas were constructed by soldering a $\frac{\lambda}{4}$ piece of copper wire to the inner-conductor and a $\frac{\lambda}{4}$ to the outer conductor of the RG-58 coaxial cable resulting in the $\frac{\lambda}{2}$, half-wave Dipole antenna. Then RG-58 to BNC male connector was crimped to the RG-58 coaxial cable. The RG-58 coaxial cable was cut longer due to a miscalculation of the wavelength as well as not factoring in the size of the BNC connectors and power divider. This resulted in 6cm long antennas that have 18cm of coaxial, instead of the 6cm desired. A design schematic and construction photos are provided in the figures below.

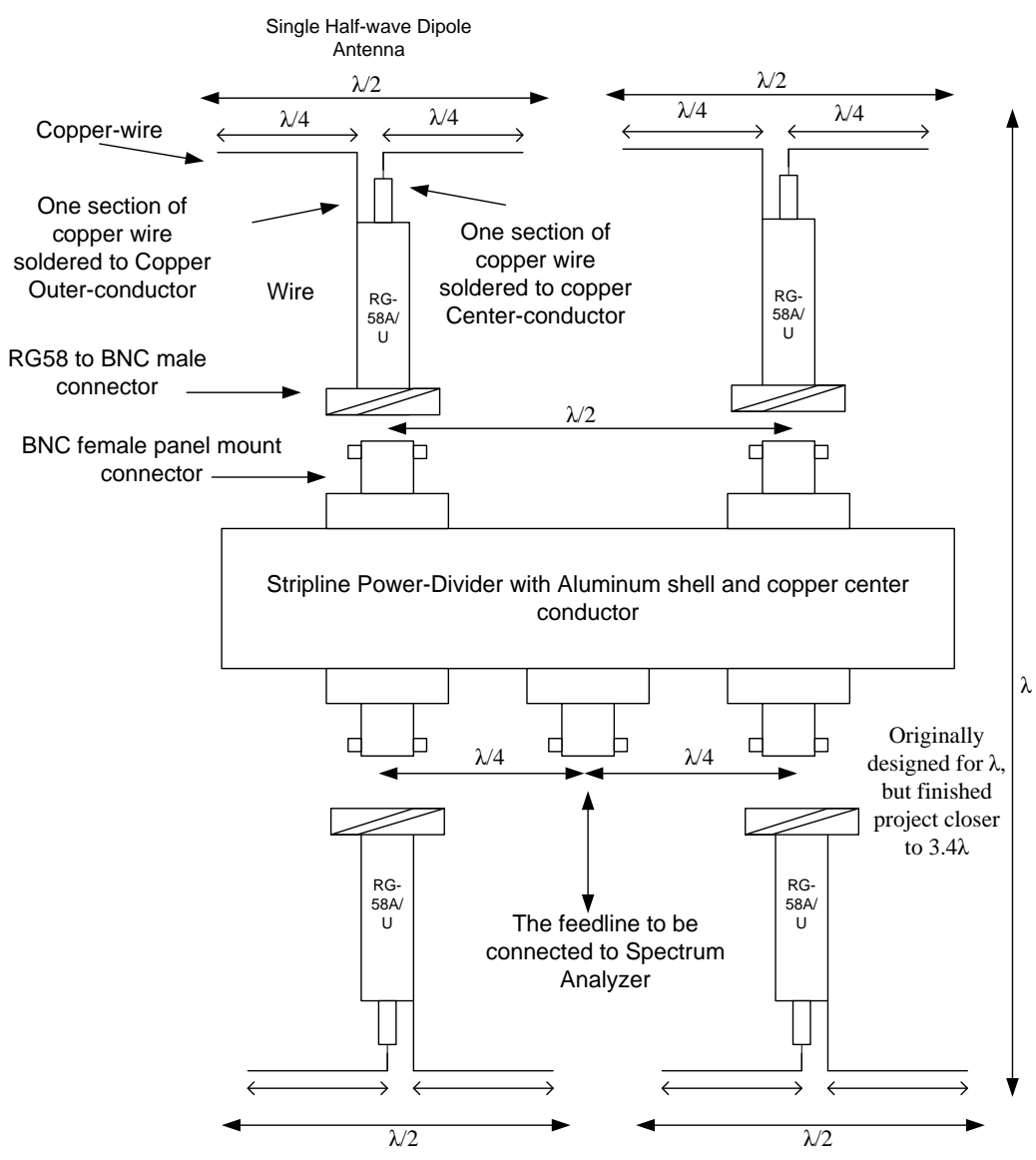

Figure 20: The general design of the 2 by 2 Dipole array.



Figure 21: The Dipole Antennas after construction and before electrical tape was used to make the separation between the two quarter-wave wires smaller. Construction of the stripline power divider with a side view as well as a view of the center conductor. The completed 2 by 2 Dipole Antenna Array.

The Stripline Power divider was made of a copper center conductor and aluminum waveguide with WR-90 specifications of 0.9 inches by 0.4 inches (Whitsel, n.d.). First the aluminum sheet was trimmed to be 4 inches by 2.6 inches. The length was chosen to be 4 inches to provide room on each side of the BNC female panel mounts. The length could have been closer to the half-wave length of 2.46 inches. After holes were drilled for the BNC female panel mounts, the aluminum was bent into the desired dimensions. The flat panel mounts were then glued to the aluminum. Once the mounts had set, the copper center conductor was soldered to the BNC feeders and bent as close as was possible while attempting to keep the surface which the panel mounts were glued to still flat. Aluminum foil was used to cover the space while plastic ties and electrical tape were used to keep the foil in place. A continuity check using a multi-meter was used to verify each BNC female mount was connected.

The construction of the 2 by 2 array with Wilkinson Power Divider

The Wilkinson power divider consisted of six microstrips, three 100Ω resistors, wire, and the insulating board with aluminum foil glued to the bottom. The building of the 2 by 2 array was easier to implement but the end product was not as durable as the stripline design. The insulating board was a composite material that looked like wood and the staples tended to wiggle loose when it was being handled. The aluminum foil around the edges was trimmed to cover the bottom of the insulator. The separation between the Monopoles on the ends was $\frac{\lambda}{4} = 3.125cm$, and the distance between the two sets was $2\lambda = 25cm$. The wires representing the Monopoles were $\frac{\lambda}{4} \times factorA = 3cm$ in length. The initial lengths were longer but were trimmed when tested. The wire connecting the Wilkinson power divider to the N-type female connector was soldered, but the connector was accidentally left ungrounded.

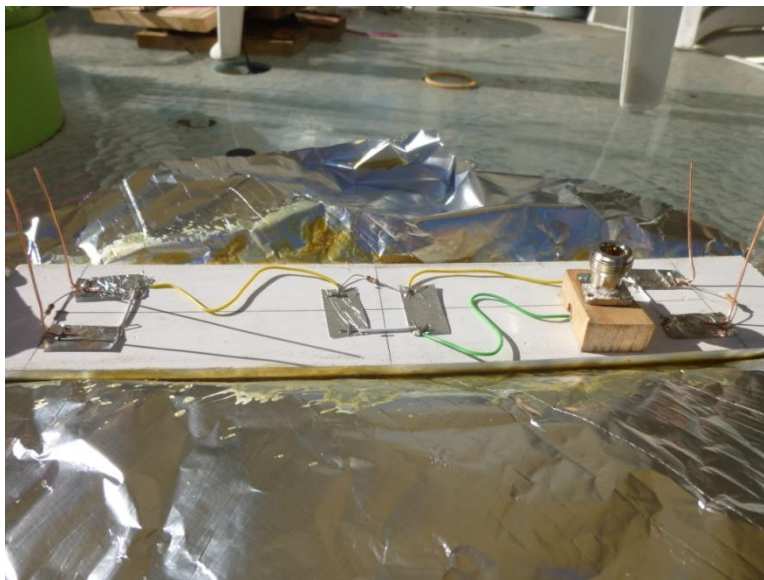

Figure 22: The 2 by 2 Monopole array using three stages of the Wilkinson Power divider.

7. Experimental Results

Testing Procedure

- 1-Calibrate Spectrum Analyzer
- 2-Set up antenna and tie a string to a stool or tripod within two feet
- 3-Measure S_{21} while walking around in 10 degree increments for the XY, XZ, and YZ planes
- 4-Use the data to make a polar plot to see the radiation pattern

2 by 2 Dipole array with Stripline

Before making measurements the spectrum analyzer was calibrated using the method Professor Kwok described when no calibration tool is available. The S_{11} was stored to memory and subtracted from the current data, and S_{21} was stored to memory and the new data was divided by the memory. The reference antenna was a larger length dipole of same coaxial cable design which at 734MHz had an $S_{11} = -20dB$, shown in the figure below.

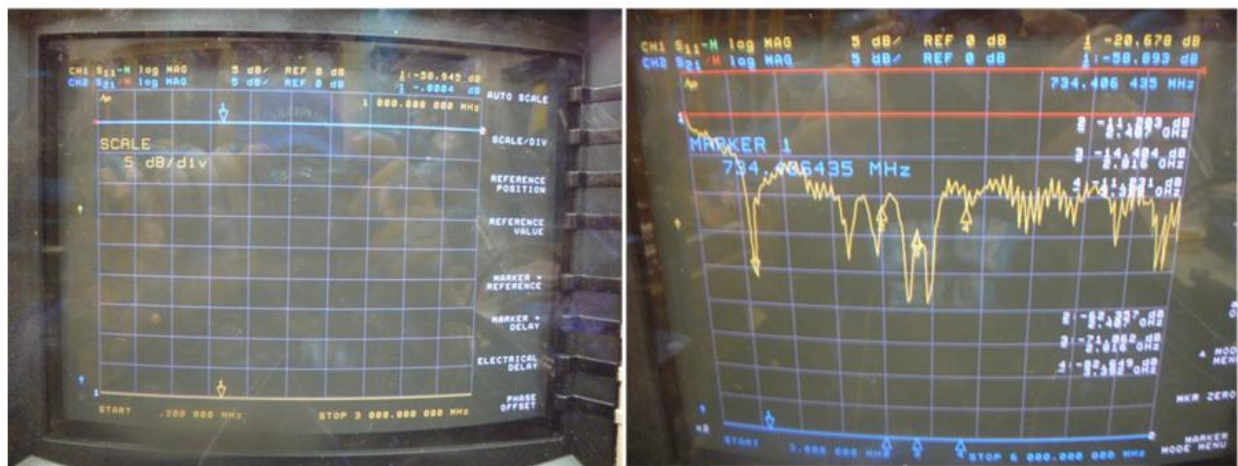

Figure 23: Calibrating the Spectrum Analyzer. Image on the right, the reference antenna used with -20.6dB at 734MHz.

Each antenna was connected and trimmed to get a S_{11} in the -15dB range around 2.4GHz. The lengths of the copper wire representing the Dipole antennas varied for each antenna. They ranged from 5.7cm, 6.2cm, 6.4cm, and 6.8cm.

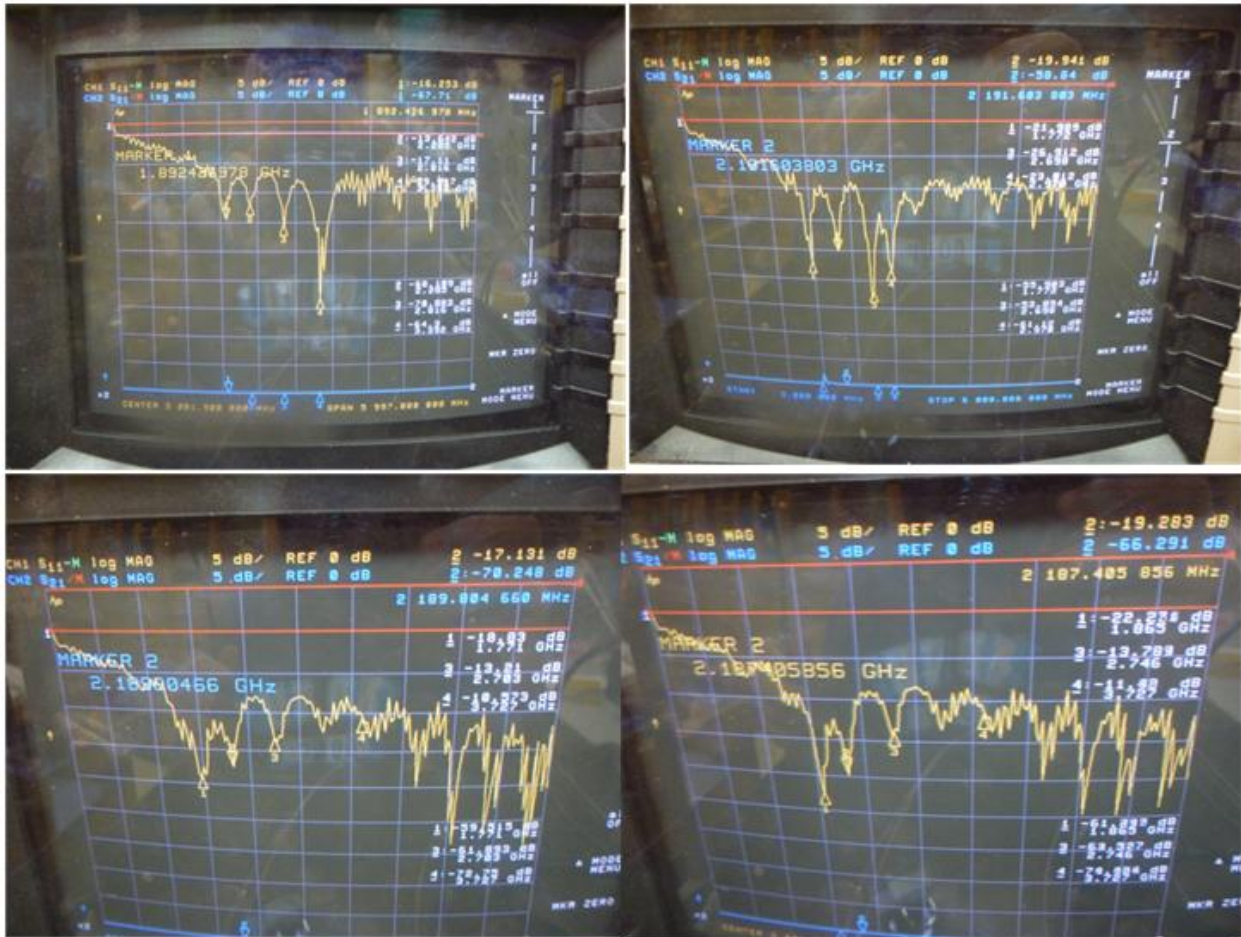

Figure 24: Antennas with -13.6dB at 2.28GHz, -19.9dB at 2.19GHz, -17.1dB at 2.18GHz, and -19.2dB at 2.18GHz .

The antennas designed for 2.4GHz S_{11} 's ranged from -13.6dB to -19.9dB at frequencies around 2.18 to 2.28GHz. Each antenna had better S_{11} 's at other frequencies but these were the closest frequencies to the desired 2.4GHz. Measuring the radiation pattern for the 2 by 2 Dipole array with stripline power divider, the S_{21} was measured by putting the array on a stool with a cardboard box, or the second method was to tape the array to a tripod. Both setups had positions where a full 360 degree measurement could be difficult to make, that was the reason for both

setups. Measurements were taken every 10 degrees using a piece of cardboard in the lab with the positions labeled in 10 degree increments. To keep a consistent distance from the array the reference antenna had a string tied to the base of the stool and tripod for each case. The goal was to keep the string snug enough while not tipping the stool or tripod over, shown in the figures below.

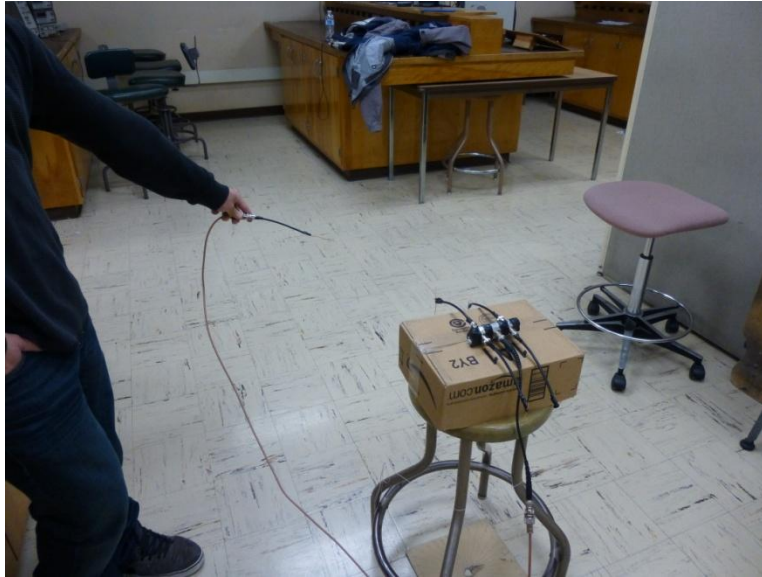

Figure 25: The test setup with the stool and string. The string was used to keep a consistent distance from the 2 by 2 Dipole array.

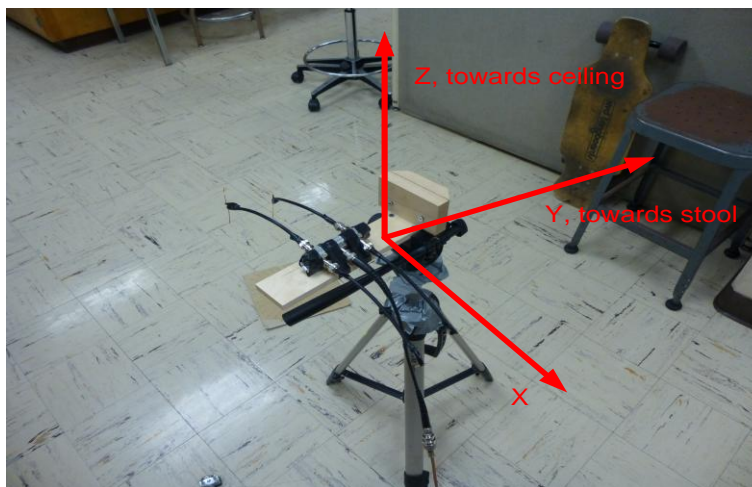

Figure 26: The test setup with the tripod and string.

Radiation patterns of the 2 by 2 Dipole Antenna

The XY-plane radiation plots

The resulting radiation patterns were produced in Microsoft Excel using the data. No real similarity was noticeable between the measured and simulated patterns in the XY-plane. This could be due to the side lobes of the simulated version being sharp while the method for measuring the actual radiation pattern was determined in 10 degree segments. The plots are shown below, plotted using the S_{21} measurements.

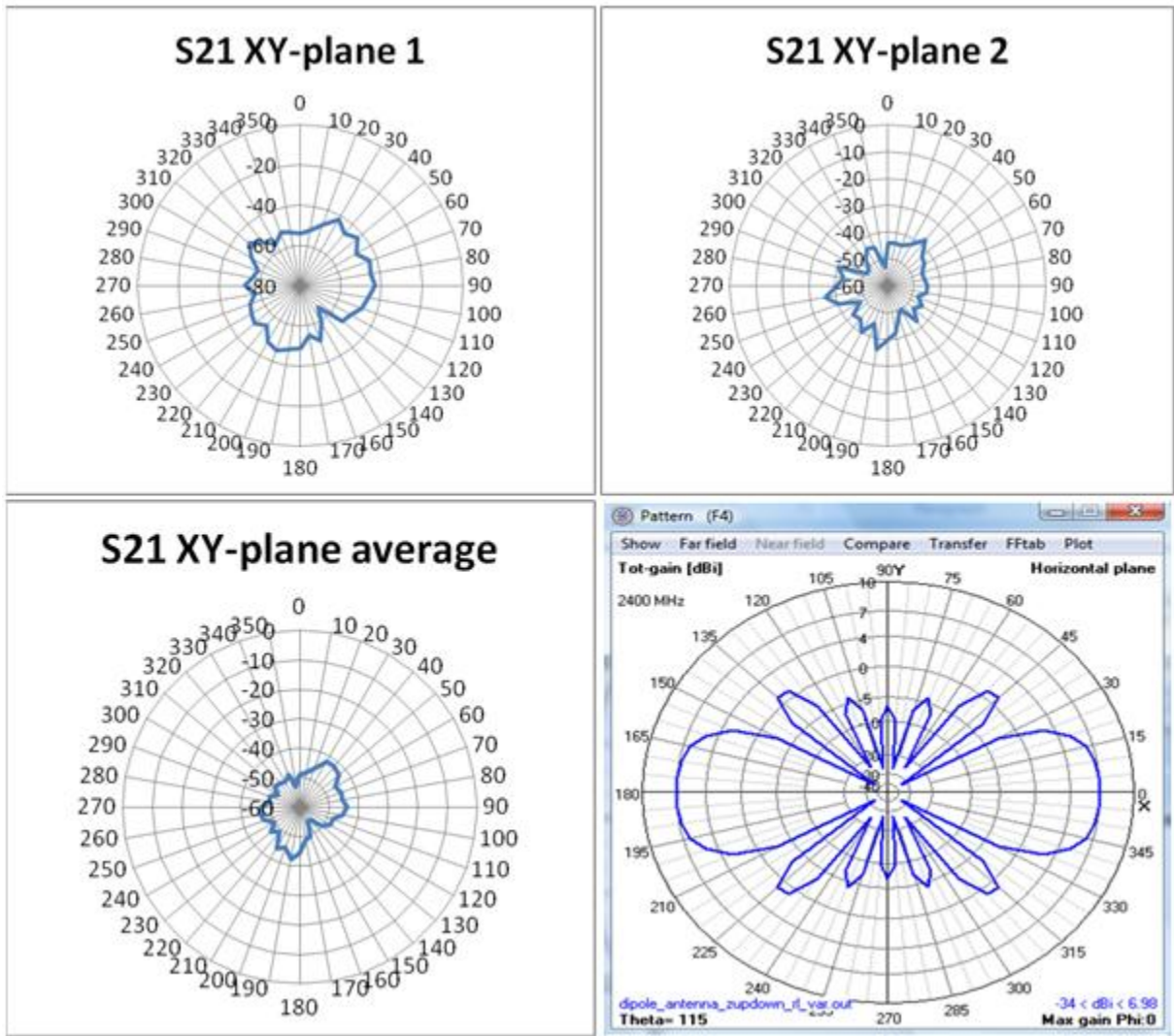

Figure 27: The XY-plane radiation patterns along with the 4nec2 simulated radiation pattern.

The XZ-plane radiation plots

The similarity between the measured and simulated radiation pattern is apparent, the plots are shown below. The pattern for the measured radiation patterns has two main bulges and some side lobes, which is similar to the simulated radiation pattern. The measured patterns do not have as many side lobes or the dip in the main lobe like the simulated pattern. The orientation of the simulated XZ-plane needs to be shifted by 90 degrees due to the 90 degree difference in the simulated and physical orientation of the plots. Once the orientations of the simulated and physical 2 by 2 Dipole array are aligned the similarities in the radiation patterns are noticeable.

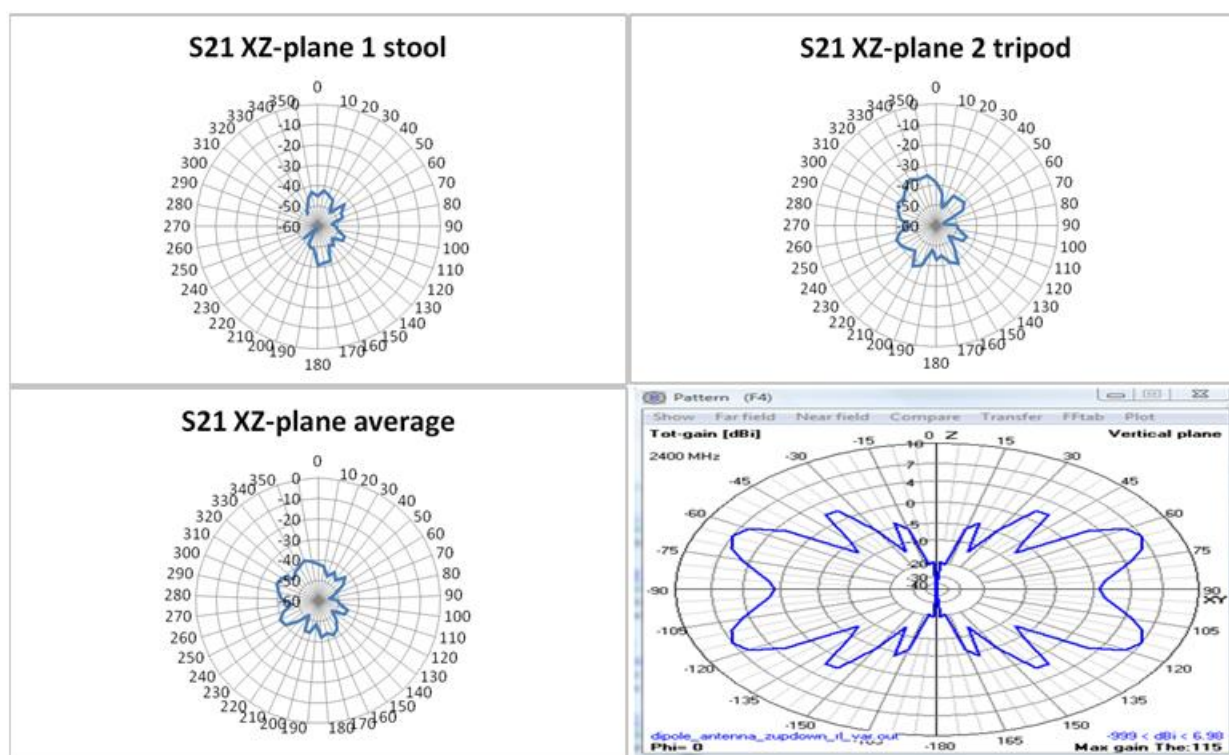

Figure 28: Data was not gathered from 230 degrees to 310 degrees due to the space under the stool. So the average plot does not take those missed places into consideration. The simulated 4nec2 radiation pattern is also shown.

The YZ-plane radiation plots

Some similarities between the measured and simulated radiation patterns, no plot stands out as very similar. What can be seen is that measured patterns have four lobe areas, two large lobes and two smaller side lobes, while the simulated version has two dented main lobes with four side lobes.

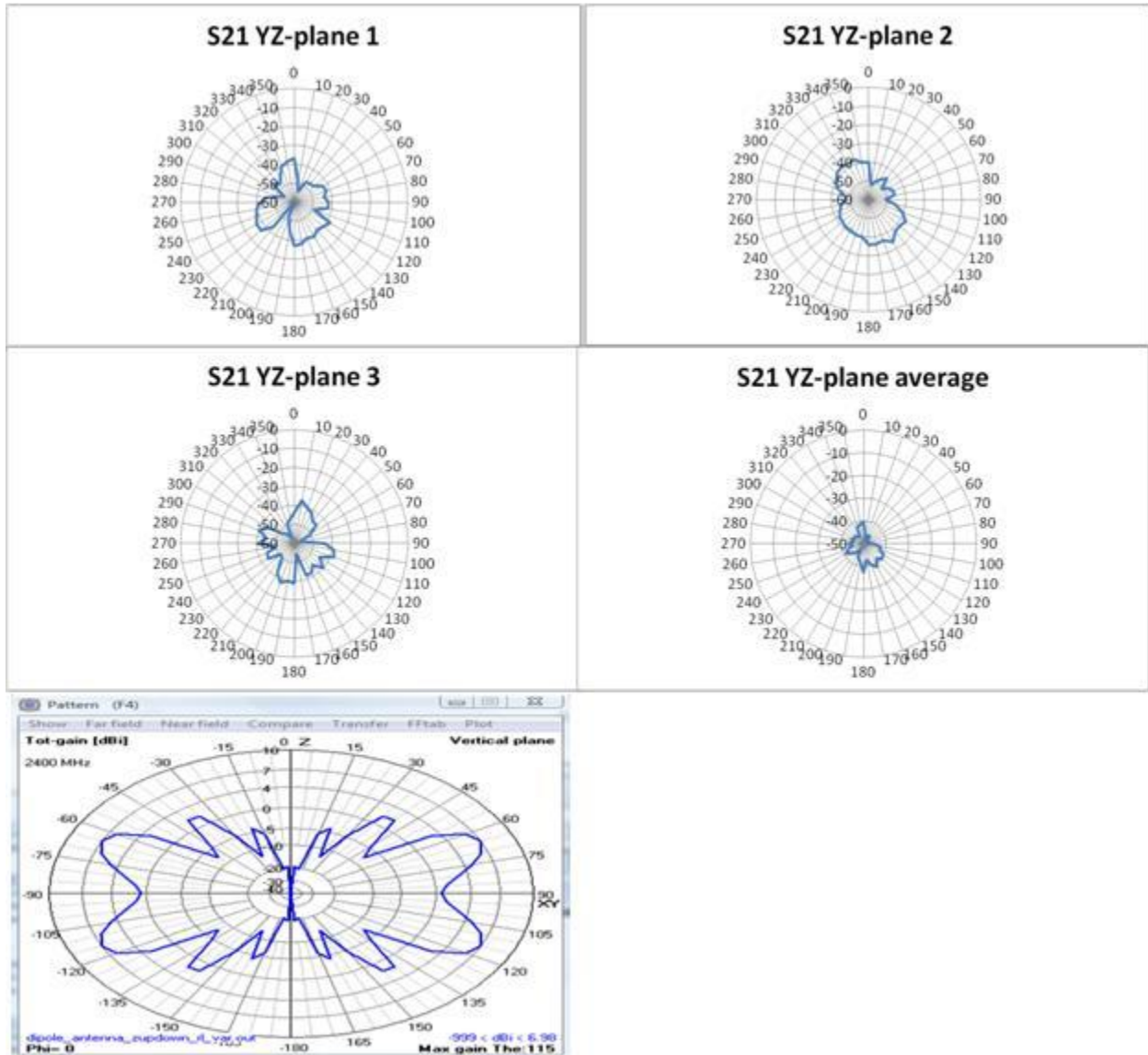

Figure 29: The Radiation patterns for the YZ-plane.

Measured Radiation Patterns of the 2 by 2 Monopole Array with Wilkinson power divider

The 2 by 2 Monopole setup was not heavy or sturdy which became a problem when trying to keep the setup flat when connected to the spectrum analyzer. As a result the setup was placed on top of the spectrum analyzer, shown in figure below. A string was taped to the surface of the spectrum analyzer to keep the reference antenna a consistent length from the 2 by 2 Monopole array. For the radiation patterns below, 180 degrees of the S_{21} was measured and then inverted for the polar plot representations, and that is noted by the red and blue color in the polar plots. The S_{11} was -31.7dB at 2.66GHz. The data is not valid, during the presentation it was noticed by Professor Kwok that the N-type female connector was not grounded. The gathered data and plots from the measurements are still provided below.



Figure 30: The setup and S_{11} measurement.

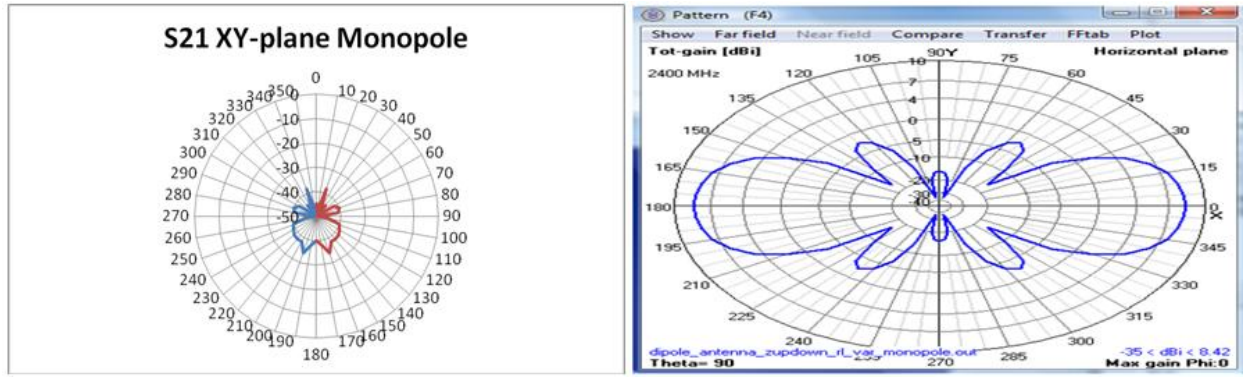

Figure 31: The Measured XY plane radiation compared with simulated pattern.

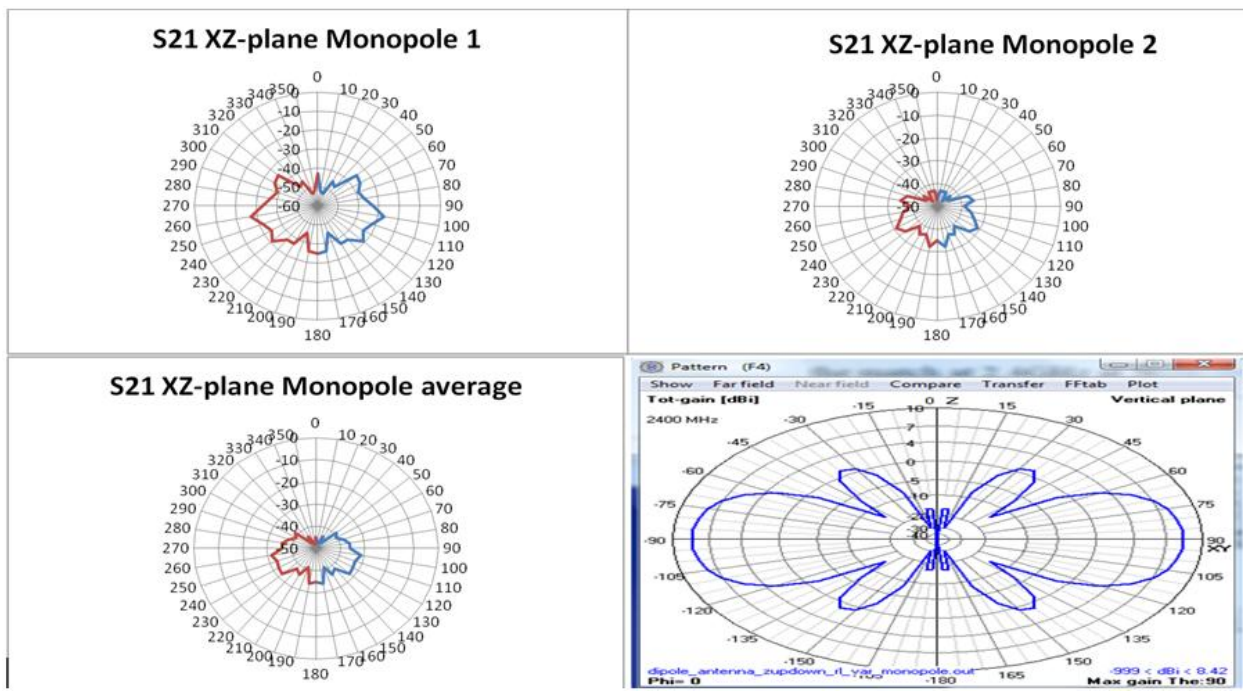

Figure 32: The measured radiation pattern compared with the XZ-plane

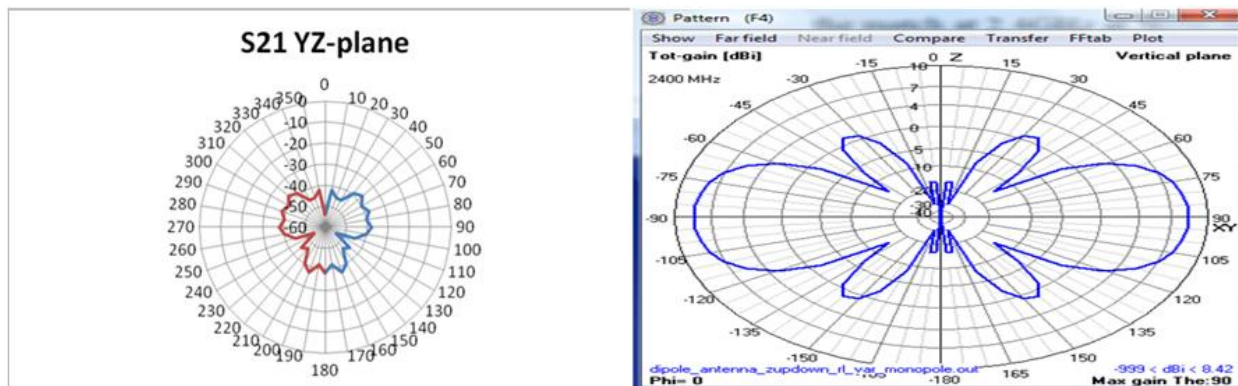

Figure 33: The radiation patterns of the YZ plane and the simulated pattern.

8. Conclusion

The radiation patterns for the 2 by 2 Dipole antenna showed some similarities in the XZ-plane and YZ-plane. The 2 by 2 Monopole array had serious issues with implementation and as a result the data was not usable. Each 2 by 2 array will be discussed in more detail below. After building the 2 by 2 Dipole and Monopole arrays, the exposure to new concepts such as microstrips and striplines were made easier to implement with the aid of software, such as Microwave Office and 4nec2.

The Dipole antennas were built using coaxial cable that could have been more balanced by implementing a Balun to improve the performance of the antennas (Stutzman, 1981, pp. 216-218). This was not done since the Dipole antennas' measured S_{11} 's before calibrating the spectrum analyzer were higher than the measured S_{11} 's after calibration. The length of the copper wire for each Dipole varied from the theoretical calculations and the actual lengths after trimming ranged from 5.7cm to 6.4cm, while the expected length, $\frac{\lambda}{2} = 6cm$, with the factor A ratio included based on the wavelength and the diameter of the wire. Each length of copper wire on the antenna was trimmed to have peaks in S_{11} near 2.4GHz. The S_{11} 's for the antennas ranged from -13.6dB to -19.9dB at frequencies from 2.18 to 2.28GHz. Professor Kwok's recommendation to build these devices at lower frequencies makes sense now since the first antenna that was made was at 900MHz and before being trimmed it was easier to gauge the length of the copper wire with respect to the frequency. As the wire became shorter it became harder to gauge the amount of wire to be trimmed and the frequency at which it performed best. The stripline power divider from the TXline editor had an inner and outer conducting layer of the same material, but in this implementation there were two materials used, copper and aluminum.

The inability to close the gap on the aluminum waveguide proved to be an issue and could have impaired the measurements and functionality of the stripline power divider. A continuity check using a multi-meter was used to verify each BNC female mount was connected. The performance of the stripline power divider was not tested and as a result, not verified to be functioning properly, this was brought up during the presentation. The stripline power divider should have been tested with 50Ω terminators as mentioned by Professor Kwok during the question and answer portion of the presentation. This will be done when testing future projects. The Dipole antennas did not hold their shape and sagged during measurements, this was brought up as a potential problem. In the future, some mechanism will be used to hold the coaxial cables straight so that the dimensions of the 2 by 2 array are consistent.

The 2 by 2 Monopole Antenna radiation patterns did not appear to match the simulated patterns and since the N-type connector was not properly connected (noticed after data gathered), the data was not valid. The Monopole design required a perfect ground plane in order to act like a Dipole antenna with image theory. Since the aluminum strips were not large in size, the ground plane may have not been large enough, and the setup could have been seriously flawed. Not being able to check the S_{11} for the individual Monopoles to see their performance like in the Dipole coaxial antennas, left a lot to be determined. The Wilkinson power divider stages should have tested to ensure proper operation. The wire connecting to the N-type panel mount connector may have affected the 50Ω match that was expected. For future designs a quarter-wave microstrip with 50Ω characteristic impedance could be used to connect to the N-type connector. The N-type panel mount connector was not grounded and as result the measurements are invalid for the 2 by 2 Monopole array. The connector is shown below.



Figure 34: The N-type female connector on the 2 by 2 Monopole array that was not grounded.

The two projects helped bridge the gap between theory and implementation. Implementing designs and taking the proper measurements for the data proved to be difficult. Knowing what to test, how to test it, and the proper methods used to test it were all new. This was my first project dealing with antennas and power dividers and a lot of mistakes were made due to inexperience. Not connecting the N-type connector to ground for the 2 by 2 Monopole was a mistake that should not have been made, but was due to inexperience. After this experience the importance of implementing designs that are easily testable is even more apparent. The 2 by 2 Dipole had various sections that made testing the individual parts possible. The 2 by 2 Monopole design made testing sections of the project difficult to implement. The functionality of the microstrips, antennas, and the Wilkinson power were not verified for the 2 by 2 Monopole array. Even with the mistakes, the two 2 by 2 array projects helped with the understanding of concepts due to the hands on approach of taking theory and implementing that theory into tangible devices. This project exposed new concepts, and made it clear that there are many ways to create a power divider and 2 by 2 antenna array with different radiation patterns due to the spacing between the antennas. Gaining hands on experience designing these projects proved to be helpful in the understanding of the theory and implementation of antennas and power dividers.

9. Bibliography

1. *Amateur Radio Antenna Facts*. (n.d.). Retrieved November 26, 2012, from KC9AOP.net:
http://www.kc9aop.net/HAM/antenna_facts.htm
2. Balanis, C. (2005). *Antenna Theory 3rd Edition*. Hoboken, New Jersey: John Wiley and Sons.
3. *Electronics+Radio Today*. (2012, November 18). Retrieved November 18, 2012, from Electronics+Radio Today: <http://www.electronics-radio.com/articles/radio/antennas/Dipole/Dipole-antenna.php>
4. Fusco, V. F. (2005). *Foundations of Antenna Theory and Techniques*. Harlow, England: Pearson: Prentice Hall.
5. Gibilisco, S. (2005). *Electronics Demystified*. New York: McGraw-Hill.
6. <http://www.nr6ca.org/vf.html>. (n.d.). Retrieved December 2, 2012, from <http://www.nr6ca.org/vf.html>
7. Pozar, D. M. (2012). *Microwave Engineering*. Hoboken: John Wiley and Sons.
8. Sedra, A., & Smith, K. (2010). *Microelectronic Circuits 6th edition*. New York: Oxford University Press.
9. Stutzman, W. (1981). *Antenna Theory and Design*. New York: John Wiley and Sons.
10. Tao, H. (2011, May 25). Retrieved from EE172-Introduction to Microwave Engineering:
http://www.engr.sjsu.edu/rkwok/projects/Dipole_array_Hanbo%20Tao.pdf
11. Voors, A. (n.d.). *4nec2*. Retrieved from <http://home.ict.nl/~arivoors/>
12. Whitsel, R. J. (n.d.). *Stripline Power Dividers using Waveguide*. Retrieved December 2, 2012, from <http://www.packratvhf.com/article4.htm>:
<http://www.packratvhf.com/article4.htm>